



# CONSTRUCTION TRAFFIC MANAGEMENT PLAN

January 2020



## Rush Wall Solar Park



**acstro**

## Table of Contents

1	Introduction & Purpose .....	1
2	Existing Conditions .....	3
3	Proposed Development .....	4
4	Vehicular Access Arrangements .....	5
5	Construction Traffic Management Measures .....	8
6	Summary & Conclusion .....	10

## Appendix 1 Proposed Green Street Construction Traffic Access

### Revision History

Issue 1	17 <sup>th</sup> January 2020	
Issue 2	29 <sup>th</sup> January 2020	

1243 Rush Wall SolarCTMP.docx

This report has been prepared for the exclusive use of our client and unless otherwise agreed in writing by Acstro Limited, no other party may copy, reproduce, distribute, make use of, or rely on the contents of the report. Acstro Limited assumes no responsibility to any other party in respect of or arising out of or in connection with this document and/or its content.

© 2020 Acstro Limited

Acstro Ltd., Ty Penbryn, Salem, Llandeilo, SA19 7LT  
[www.acstro.com](http://www.acstro.com)  
 T. 01558 824021  
 E. [mail@acstro.com](mailto:mail@acstro.com)



## 1 Introduction & Purpose

- 1.1 This Construction Traffic Management Plan (CTMP) has been prepared in respect to the proposed Rush Wall Solar Park Project, Longlands Farm, Redwick. A site location plan is provided below.

**Figure 1 Location Plan**

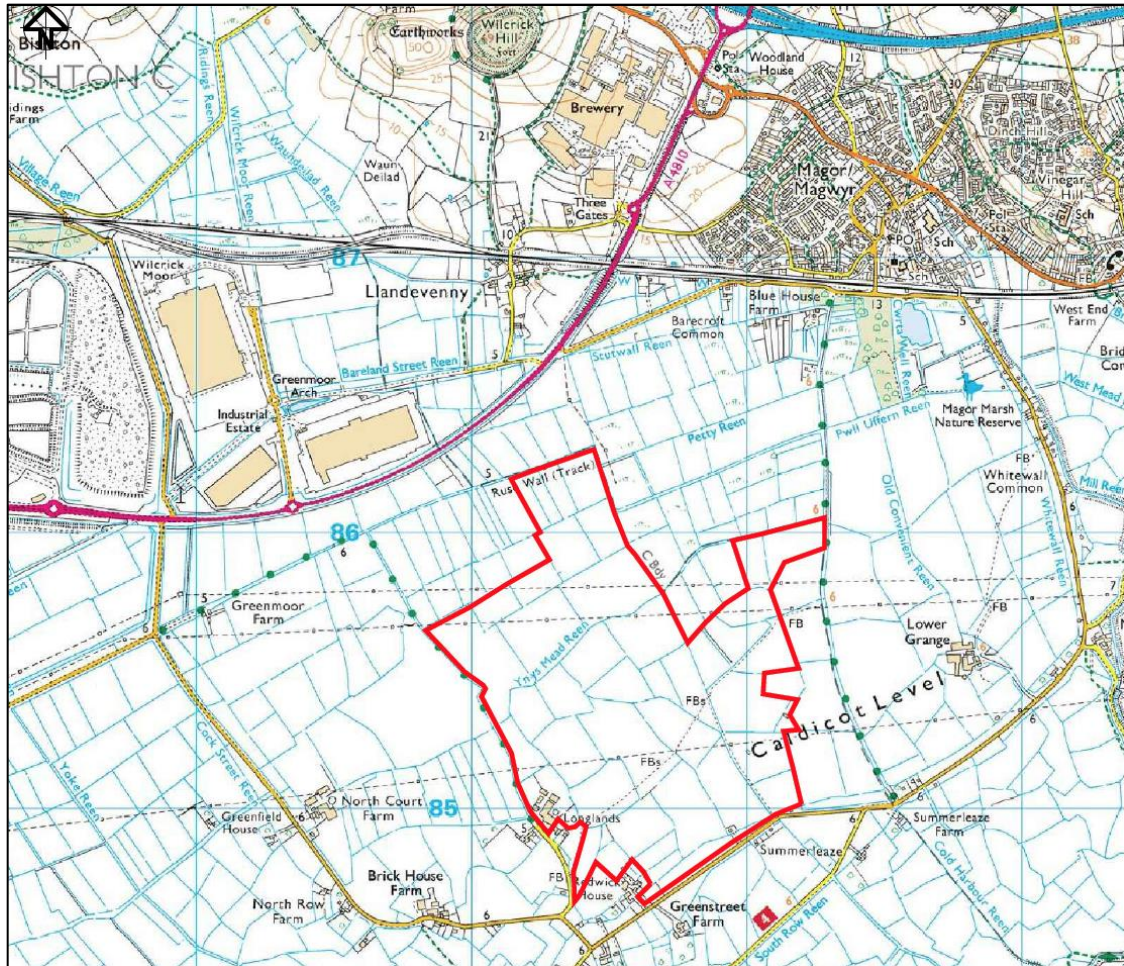

- 1.2 The purpose and aim of this CTMP is to outline the measures to be followed by all persons and companies visiting, travelling, or delivering items to the site. The guidance will provide information on the safest and best practice procedures to follow when considering movements to and from site by all construction vehicles.
- 1.3 Following this plan will help to reduce the negative effects of off-site construction traffic on the local environment. It will set a standard to follow which has the safety of all road users as its core value.
- 1.4 This is a live document and is subject to change as the scope of work develops and site conditions change.
- 1.5 It is expected that it will be a condition of the planning approval that a CTMP will be submitted for the approval of Newport City Council prior to the commencement of the development and that the development then be carried out in accordance with the approved CTMP.

- 1.6 The content of the CTMP will be communicated at the following appropriate points:
  - Sub-contractor Tender Enquiries
  - Letter drops / posters to the local community
  - The Pre-Start Health, Safety and Environmental meetings
  - All site inductions will include a section on the CTMP
  - During on-going Toolbox Talks throughout the course of the works
- 1.7 Close contact will be maintained with local residents, the Community Council and neighbours throughout the project to deal with any issues as they arise.
- 1.8 The public will be informed about the site activities, particularly those which have a potential to cause disturbance and those interfering with traffic movements, by an appropriate medium. Neighbouring residents who will be most affected by the construction of this project will be informed of any activities which may disrupt them.
- 1.9 This will be done by a letter or personal visits in advance of the works, and will continue throughout the duration of the works. Throughout the period of the works a nominated member of staff to act as a point of contact to manage liaison and handle local issues and points of concern.

## 2 Existing Conditions

### The Site

- 2.1 The proposed solar farm will be located at Longlands Farm, approximately 1km north of Redwick.
- 2.2 The fields are bordered by drainage channels (called reens) or hedgerows or both. The main reens on the site or adjacent to the site (Ynys Mead Reen and the Reen one field north of Green Street) are cleared annually by Natural Resources Wales (NRW). NRW require access to these reens at all times in order to carry out this maintenance. The farm maintains the other reens on the site, mainly to remove vegetation (such as hedge trimmings).
- 2.3 Adjacent to the western site boundary there are three dwellings and the farmyard. Two of the three dwellings are owned and occupied by the farm owners. The dwelling adjacent and to the west of the farmyard, is not owned by the farm. The farmyard includes buildings to house livestock, machinery and feed, areas of hard-standing, silage storage and a slurry silo. Caravans are stored just to the north of the farm buildings on an area of compacted gravel. These areas are accessed by a short single-track tarmac road with two passing places (Longlands Lane), off North Row. Where Longlands Lane meets North Row there is a small recreation ground with children's play equipment.
- 2.4 The site is crossed east-west by three sets of overhead lines and their associated pylons. These overhead lines connect to a substation approximately 5 kilometres to the east. The farmland is flat and drained by the reen system, within which water flows slowly towards the Severn Estuary. There are no public rights of way across the site. There is a permissive path leading north from the northern end of Longlands Lane for 1.25 km before joining Rush Wall (Track). There are barriers to prevent vehicular access in two locations and the path is currently too overgrown to use along the middle section.
- 2.5 Under all the fields within the site a network of pipes has been installed to aid drainage, as is common for land in this area. 45cm under the surface of each field is a network of drainage pipes, over each there is a layer of stone. The pipes are 5 to 15cm diameter and made of clay or plastic. The pipes drain toward the drainage ditches (reens) at field margins.
- 2.6 The site is within Redwick Parish and the Newport City Council local authority area. The site's eastern boundary is adjacent to Cold Harbour Reen, which marks the border with Monmouthshire County Council.

### 3 Proposed Development

3.1 The solar park will comprise of:

- Solar photovoltaic (PV) panels, mounted to a railing sub structure;
- String inverters and associated transformers;
- Compacted gravel tracks (constructed on a sub layer geogrid membrane) to allow vehicular access between fields and a substation access track with a cement based top layer (a statutory requirement of the electricity distribution network operator, Western Power Distribution);
- Stock proof fencing and gates to enclose the panels within each field and allow sheep to graze securely;
- Security and monitoring CCTV mounted on fence posts within each field;
- Underground cabling to connect the panels to the substation;
- A substation compound (for both the customer (Applicant) and Western Power Distribution, the Distribution Network Operator (DNO), elements), including associated ancillary services, which will connect to the onsite 132kV overhead lines via a WPD tower; and
- The substation would be within a security-fenced concrete-based compound measuring approximately 50m x 40m at the centre of the site adjacent to an existing pylon. A T-off connection (i.e. an overhead wire) would provide the point of connection from the substation to the existing 132kV pylon on site. A 10 metre high single pole communications antenna may be required at the substation.

#### Construction Programme & Traffic Generation

3.2 The likely number of HGV movements throughout the construction phase is provided in the table below. The largest anticipated vehicle that will access the site during construction will be an articulated lorry.

#### Construction Phase HGV Movements

	Week																		
	1	2	3	4	5	6	7	8	9	10	11	12	13	14	15	16	17	18	
	Per week																		
Earthworks	15	15	15	15	15												5	5	5
Mounting Systems		40	40	40	5														
Modules						45	45	45	45										
Inverter / Substation					14														
Cables		30	16																
Fencing/Misc/Others	20	10	10	10	5	5	5	5	5	5	5	5	5	5	5	5	5	5	5
Total Deliveries Per week*	35	95	81	65	39	50	50	50	50	5	5	5	5	5	5	10	10	10	
Total Deliveries per Day	7	19	16	13	8	10	10	10	10	1	1	1	1	1	1	2	2	2	
Total Movements per Day	14	38	32	26	16	20	20	20	20	2	2	2	2	2	2	4	4	4	

## 4 Vehicular Access Arrangements

4.1 The access to the site for construction traffic will be from Green Street, to the south.

**Figure 2 Proposed Construction Access Location – Green Street**



- 4.2 The existing access will be improved to allow for the largest vehicles anticipated during the construction period, articulated lorries, to manoeuvre easily into and out of the site. Details of the proposed access improvement, including analysis that shows the swept paths of articulated lorries turning left into, and right out of, the site are provided in Appendix 1. The swept path analysis has been limited to these particular manoeuvres as the proposed construction traffic route that will be strictly followed will prevent construction traffic from arriving from or exiting towards the north east.
- 4.3 The construction traffic route is shown in the figure overleaf. From the M4's junction 23A construction traffic will follow the A4810, turn left onto North Row and left again onto Green Street before accessing the site. Departing traffic will follow the same route back to the M4.
- 4.4 A A4810 is a wide single-carriageway road that serves a number of distribution centres, the site of the Llanwern steelworks and ultimately links with the A48 in Newport. It is subject to a 50mph speed limit. The A4810 carries some 16,000 daily vehicle movements with around 15% of those being HGV's.
- 4.5 North Row joins the A4810 and forms the southern arm of a staggered crossroads (the northern arm being Bishton Road). A right-turn lane is provided on the A4810. Good visibility is provided in all directions.
- 4.6 North Row and Green Street are similar in character. They are lightly trafficked roads with carriageways that are approximately 4.5m to 5m wide.
- 4.7 By implementing this construction traffic route there will be no construction traffic travelling on Pill Street, Whitewall or Redwick Road. As a result there will be no construction traffic travelling through Magor village.

Figure 3 Access Arrangements

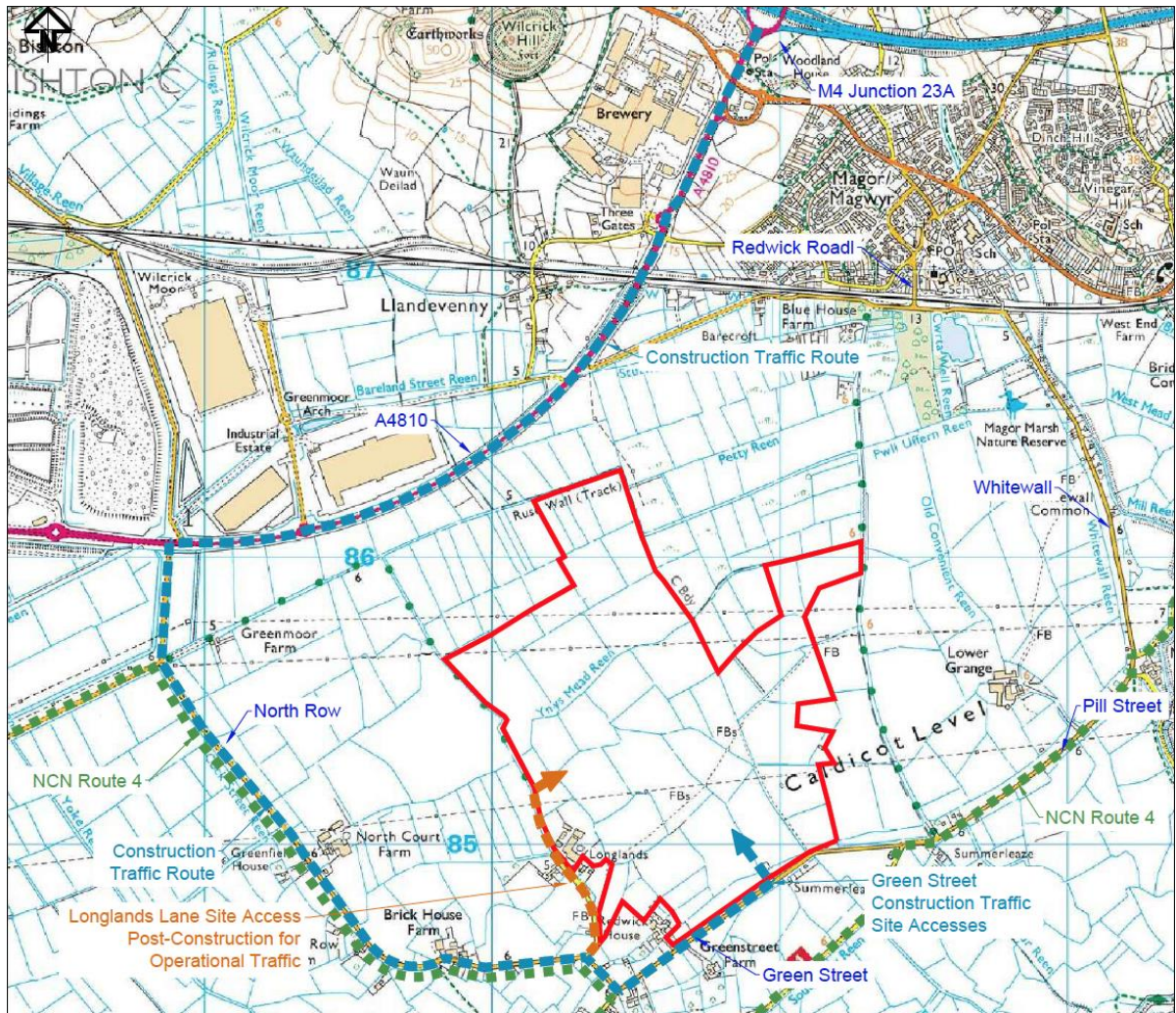



**Figure 4 A4810 / North Row Junction**



**Figure 5 North Row**



**Figure 6 Green Street**



## 5 Construction Traffic Management Measures

- 5.1 This section outlines the intended construction traffic management measures that could be introduced to mitigate any impacts resulting from the proposals, specifically during the construction phase.

### Highway Condition Surveys

- 5.2 Prior to the commencement of works a condition survey of the proposed construction traffic route and site access point will be undertaken. The condition survey will be repeated following the completion of the works.
- 5.3 In the event that the condition surveys identify damage to the public highway caused by construction traffic, the damage will be made good by the Principal Contractor in accordance with details to be agreed with the Highway Authority.

### Site Set-up & Access

- 5.4 The following measures will be adopted to safely control access to the site and manage the movement of vehicles and construction plant within it.
- Only the identified access point(s) is to be used to access and egress the site;
  - Construction traffic to adhere strictly to the specified construction traffic route;
  - The site access will be manned during working hours to ensure that access and egress to the site is adequately managed and maintain site security;
  - All drivers must report to the gateman when arriving on site;
  - All drivers must adhere to site signage and 10mph speed limit;
  - Strictly no reversing without the presence of a trained banksman;
  - All drivers must wear full PPE when leaving their vehicle;
  - Any lifting equipment e.g. Hiab/Crane must have relevant certificate prior to use on-site & documents must be inspected by the Site Manager;
  - Operatives must ensure that plant, machinery, cabins and containers are secured at the end of the working day and keys removed during meal breaks;
  - All vehicle drivers must ensure that their wheels are clean prior to entering the public highway;
  - Any members of the public attempting to enter the site with a query must be accompanied to the Site Manager's Office;
  - Deliveries will be carefully scheduled to avoid site congestion and to remove the risk of vehicles queuing to enter the site. Detailed instructions on delivery times and vehicle routing will be issued to all the site personnel, subcontractors and suppliers.

### Signage

- 5.5 Temporary signage will be erected to:
- Advise delivery drivers approaching the site of the correct route and access point;
  - Warn other road users of the increased HGV activity on the construction traffic route together with dates for the start and end of the construction activity;

- Provide details of how the contractor can be contacted during working hours and in the event of an emergency.

5.6 The precise location of temporary signage will be agreed between the Principal Contractor with NCC Highways Department.

#### Parking Arrangements

5.7 There is ample space within the site to accommodate all construction related parking demand and to accept delivery lorries within the site. No parking or unloading on the public highway will be permitted.

#### Road Cleaning

5.8 During periods of the construction there is a risk of transporting spoil (through dirty wheels) on to the road network and to mitigate this risk wheel-wash facilities will be provided.

5.9 During dry periods, damping down exposed excavations and transitional surfaces will be adopted as and when required to prevent mud / site debris from vehicles leaving the site contaminating the local highway network, whilst also helping to suppress dust.

#### Work Related Road Risks

5.10 The Principal Contractor will adopt the CLOCS standards to manage work related road risk (WRRR) beyond the boundary of the site. The CLOCS Standard is a national industry standard and sets out a series of requirements for contractors and logistics operators designed to reduce the risk of collisions with vulnerable road users.

5.11 In accordance with the CLOCS standard, it will be a requirement that all suppliers delivering to the site be a member of (or working towards membership) recognised independent audit bodies such as:

- Fleet Operator Recognition Scheme (FORS)
- Van Excellence

5.12 Some of the minimum standards that apply for vehicles are listed below:

- Operators of vehicles over 3.5T to be accredited to FORS (Bronze) or similar
  - 3.5T+ vehicles to have prominent signage fitted
  - 3.5T+ vehicles to have side under-run protection
  - 3.5T+ vehicles to have audible warning when turning left
  - 3.5T+ vehicles to have clear all round vision via CCTV, mirrors etc
- A management and reporting system in place for Collision Reporting
- Driver License checks
- Driver training and development programmes covering the safety of vulnerable road users

## 6 Summary & Conclusion

- 6.1 This Construction Traffic Management Plan (CTMP) has been prepared in respect to the proposed Rush Wall Solar Park Project, Longlands Farm, Redwick.
- 6.2 It is anticipated that the development will have an 18-week construction phase. It is anticipated that, during peak periods, some 39 HGV movements per day could be generated.
- 6.3 Construction traffic will access the site from Green Street and travel along a designated construction traffic route.
- 6.4 A number of measures are proposed that will manage the movement of construction traffic and minimise its impacts on the surrounding highway network.
- 6.5 It is expected that it will be a condition of the planning approval that a CTMP will be submitted for the approval of Newport City Council prior to the commencement of the development and that the development then be carried out in accordance with the approved CTMP.

## **Appendix 1**

# **Proposed Green Street Construction Traffic Access**





Acstro Limited  
Ty Penbryn  
Salem  
Llandeilo  
Carmarthenshire  
SA19 7LT

W. [www.acstro.com](http://www.acstro.com)  
E. [mail@acstro.com](mailto:mail@acstro.com)  
T. 01558 824021

---

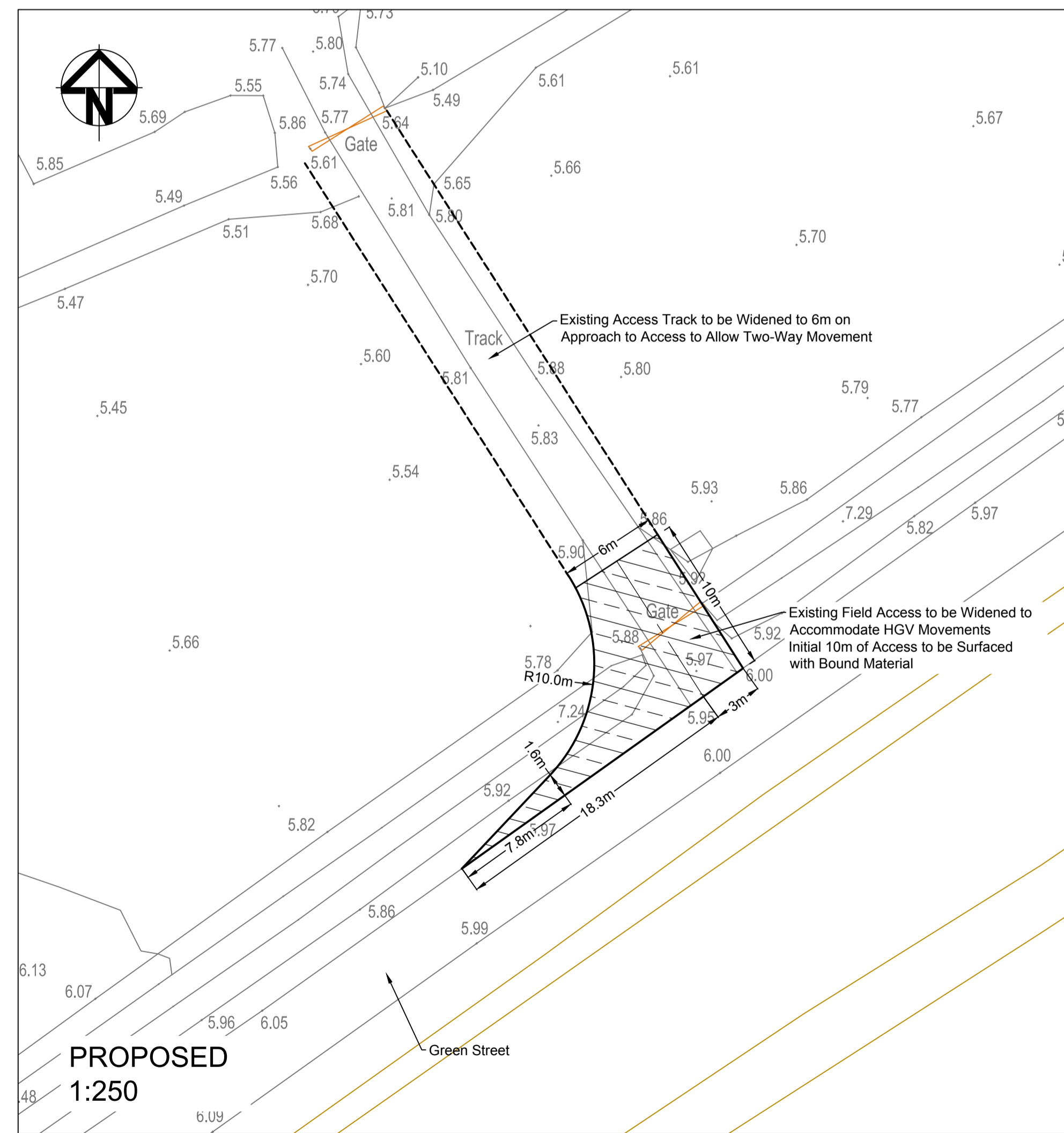
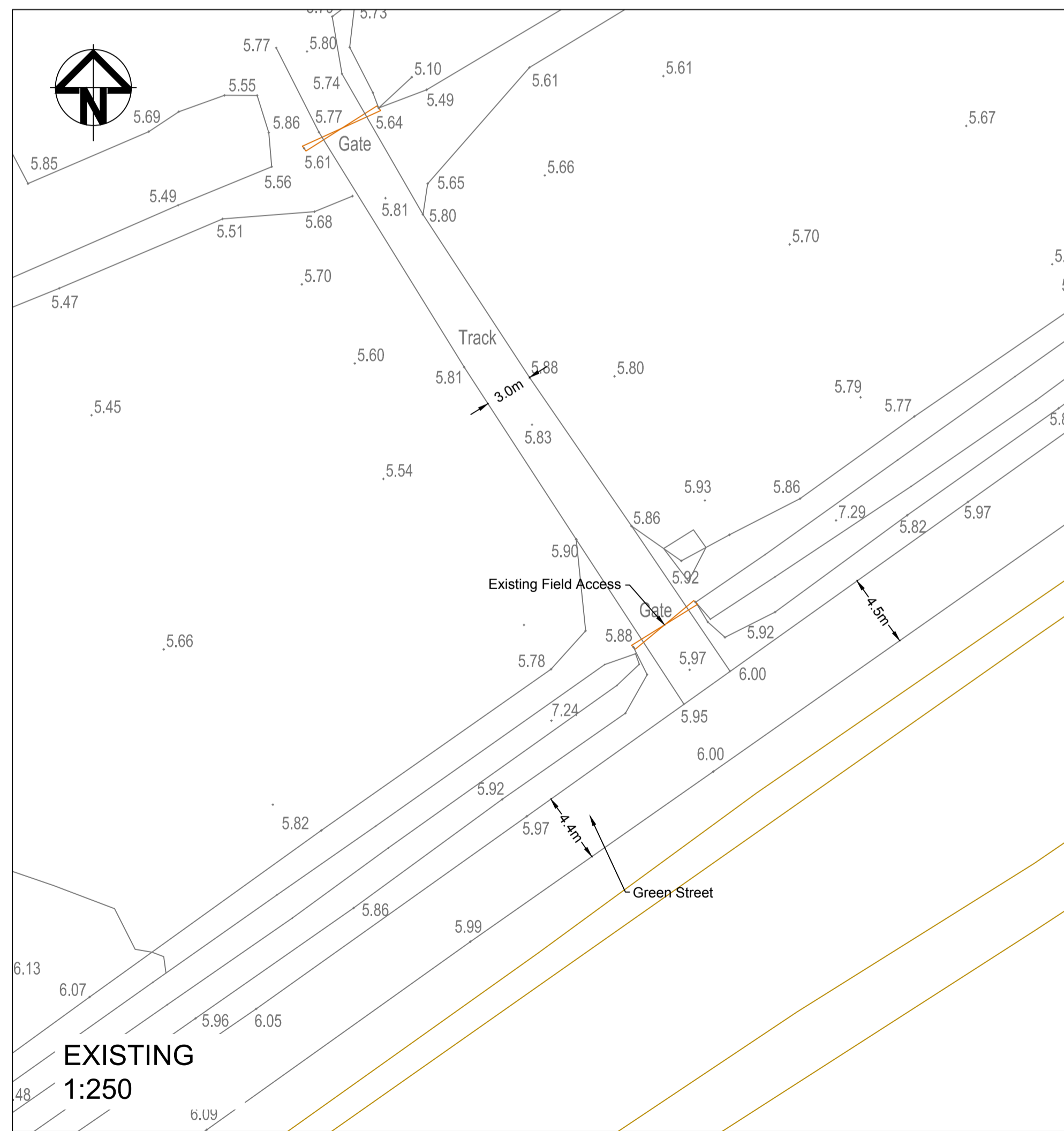
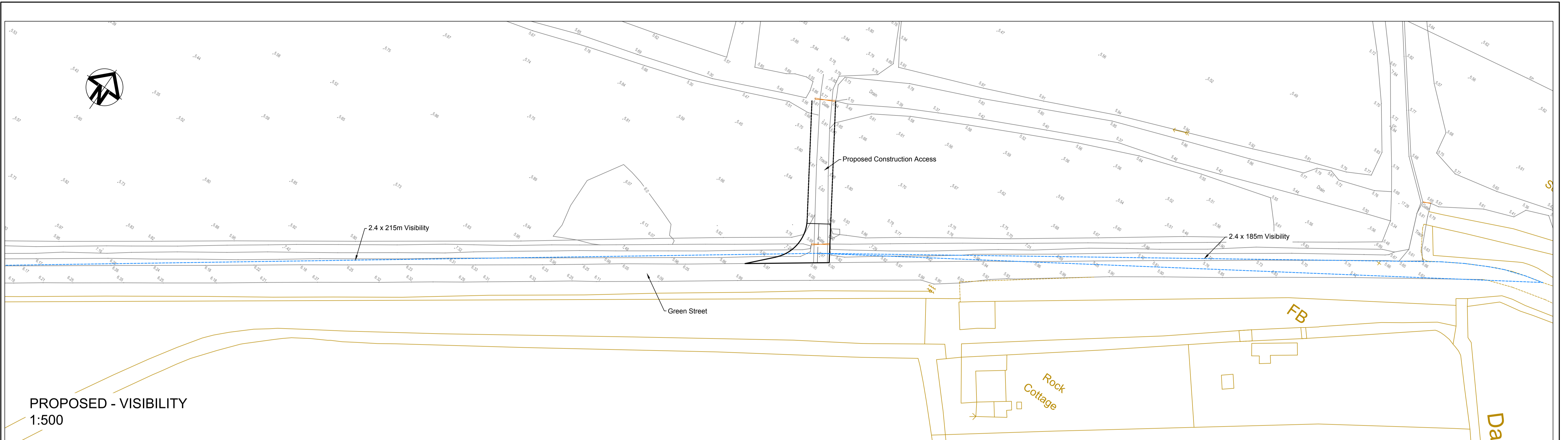



A	First Issue	28-01-20
 Prifffydd a Thrafnidiaeth Highways & Transportation Ty Penryn, Salem, Llandello, SA19 7LT E-mail: mail@acstro.com www.acstro.com Tel: 01558 824021		
<b>RUSH WALL SOLAR PARK</b>		
<b>CONSTRUCTION ACCESS</b>		
1243	004	A
1:250 & 1:500		@ A1



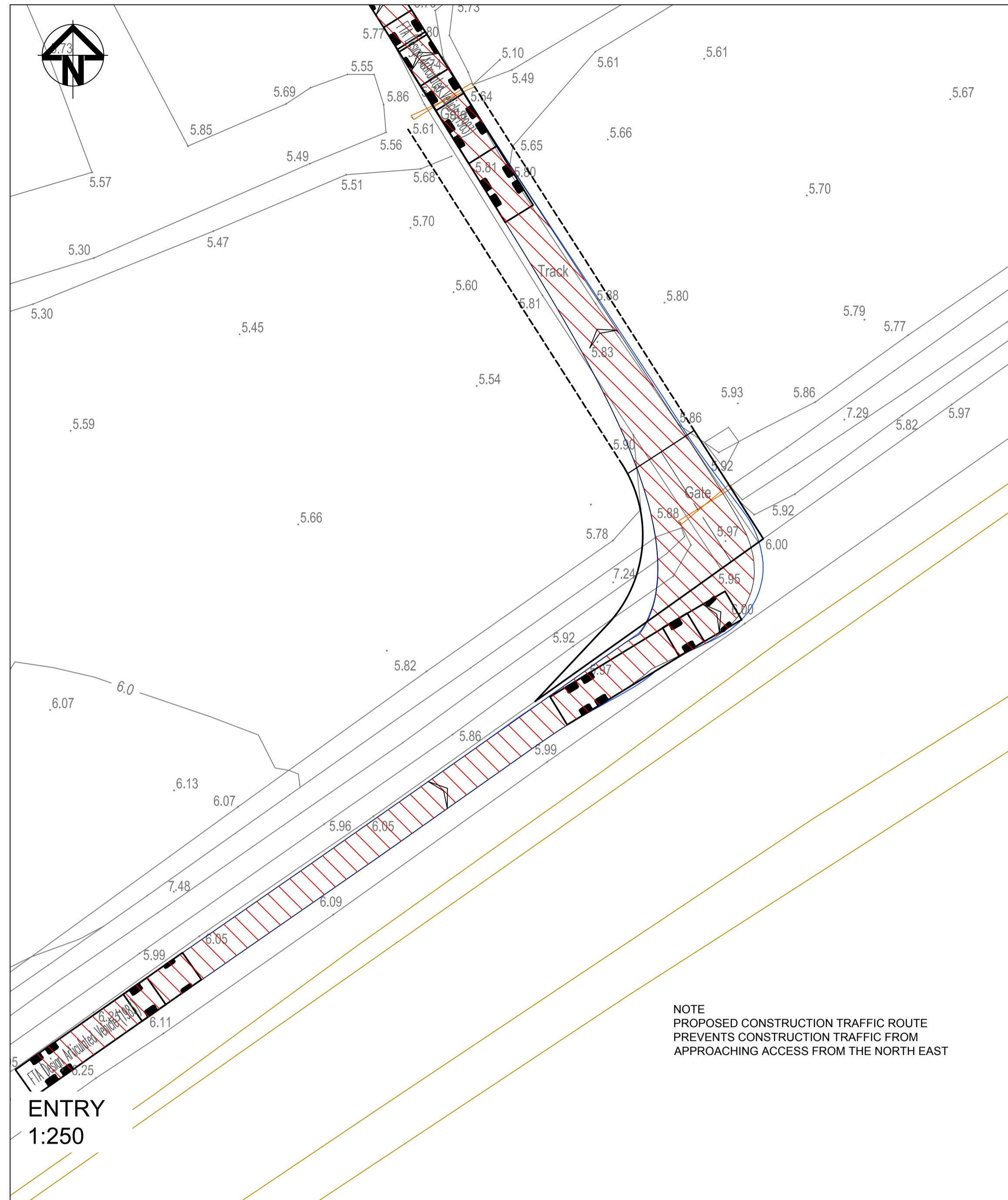

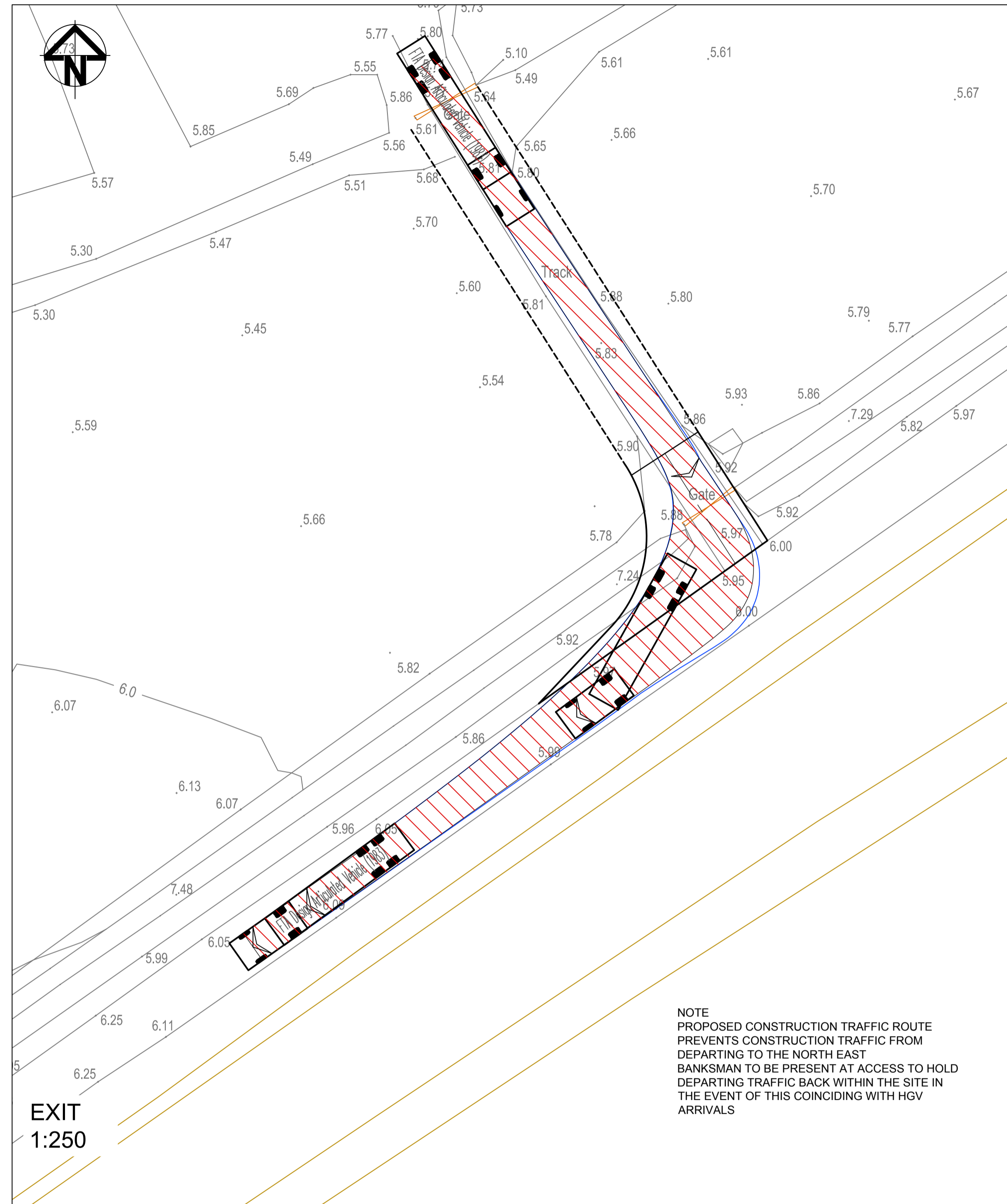

NOTE  
PROPOSED CONSTRUCTION TRAFFIC ROUTE  
PREVENTS CONSTRUCTION TRAFFIC FROM  
APPROACHING ACCESS FROM THE NORTH EAST

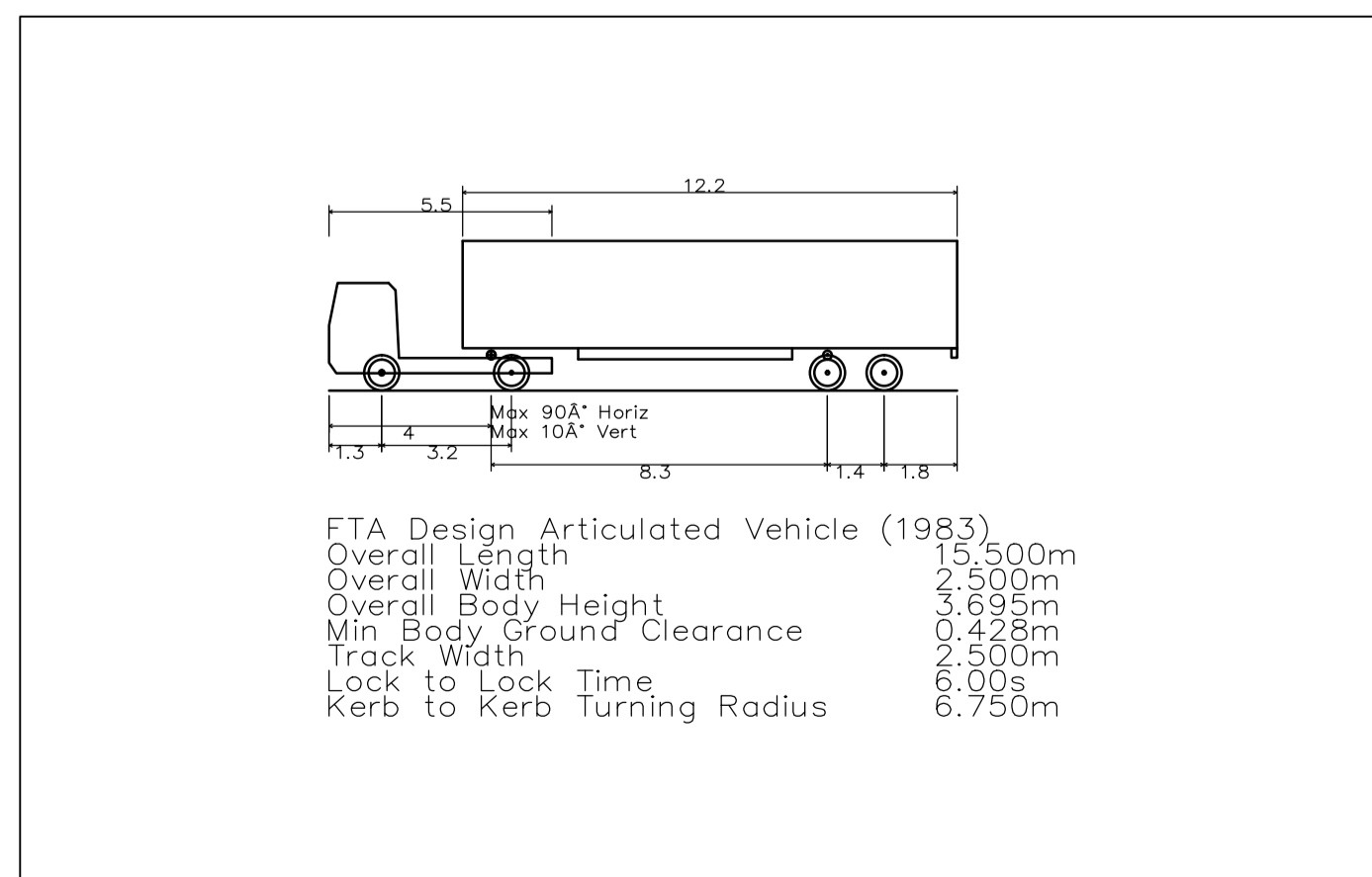

NOTE  
PROPOSED CONSTRUCTION TRAFFIC ROUTE  
PREVENTS CONSTRUCTION TRAFFIC FROM  
DEPARTING TO THE NORTH EAST  
BANKSMAN TO BE PRESENT AT ACCESS TO HOLD  
DEPARTING TRAFFIC BACK WITHIN THE SITE IN  
THE EVENT OF THIS COINCIDING WITH HGV  
ARRIVALS



A	First Issue	28-01-20
 Prifffyrdd a Thrafnidiaeth Highways & Transportation Ty Penryn, Salem, Llandello, SA19 7LT E-mail: mail@acstro.com www.acstro.com Tel: 01558 824021		
<b>RUSH WALL SOLAR PARK</b>		
<b>CONSTRUCTION ACCESS SWEEP PATH ANALYSIS</b>		
1243	005	A
	1:250	@ A1